

RECESSED TROFFER Germ Air Treatment

GRT

120 - 277vAC

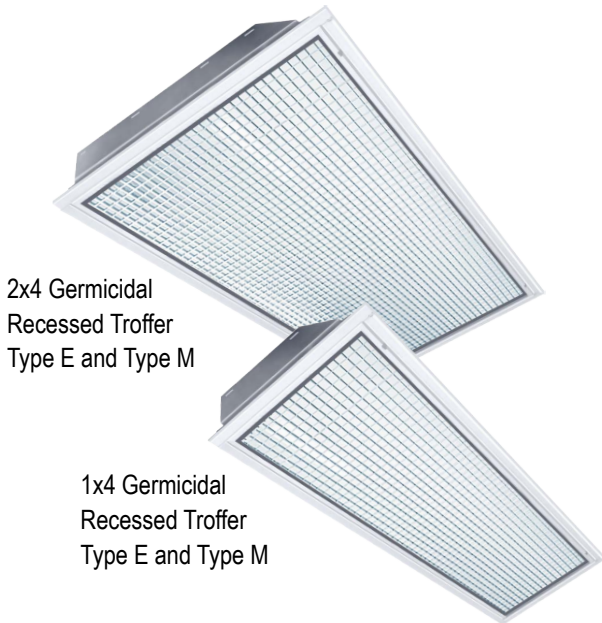

2x4 Germicidal
Recessed Troffer
Type E and Type M

1x4 Germicidal
Recessed Troffer
Type E and Type M

Lighting Solutions For
**Healthcare • Hospitality
Educational • Institutional**

Cat. #	Type
Notes	

DESIGNATIONS



KEY FEATURES AND BENEFITS

- Direct air and surface sterilization of DNA-based contaminants.
- Mounts flush with lay-in ceiling grid or plaster ceilings (Type E & Type M).
- 2' x 4' units can use two fluorescent and two germicidal lamps, or four germicidal lamps per fixture.
- 1' x 4' unit uses two germicidal lamps.
- Germicidal lamps are 254 nm / 12,000 hour life. (less than 8mg of mercury/lamp)
- Lamps are well shielded for vision safety.
- Spectrally-polished reflectors maximize UVC output.
- "Egg-crate" louver allows UVC energy to pass and additional reflectivity.

APPLICATIONS

- Hospitals
- Clinics
- Clean Rooms
- Testing Facilities
- Prisons
- Pharmaceutical Manufacturing
- Laboratories
- Institutional Buildings
- Areas requiring clean upper air treatment for occupants.

SPECIFICATIONS

Wattages 30, 60
Input Voltages 120-277vAC
Body Material Aluminum

Reflector Spectrally-polished reflective "egg crate" louvre
Ultra Violet Lamps #GML005 (Germicidal Tube)
Fluorescent Lamps #F40T12 (Fluorescent Tube)

PRODUCT ORDERING SELECTION

<p>2' x 4' Drop-In Recessed Troffer</p> <p><input type="checkbox"/> GRT-2G/2CWE (2) UVC + (2) Fluorescent Lamps</p> <p><input type="checkbox"/> GRT-36-2G E (2) UVC Lamps</p> <p><input type="checkbox"/> GML005 Replacement UVC Lamp - GRT Series</p> <p><input type="checkbox"/> BLL095 Replacement Fluorescent Lamp - GRT Series</p>	<p>2' x 4' Plaster Recessed Troffer</p> <p><input type="checkbox"/> GRT-2G/2CWM (2) UVC + (2) Fluorescent Lamps</p> <p><input type="checkbox"/> GRT-36-2G M (2) UVC Lamps</p> <p><input type="checkbox"/> GML005 Replacement UVC Lamp - GRT Series</p> <p><input type="checkbox"/> BLL095 Replacement Fluorescent Lamp - GRT Series</p>	<p>1' x 4' Drop-In Recessed Troffer</p> <p><input type="checkbox"/> GRT-36-2GE-1X4 1'X4' RT W/(2) UVC Lamps</p> <p><input type="checkbox"/> GML005 Replacement UVC Lamp for GRT Series</p>
--	--	---

Germicidal Disinfectant Fixtures for Any Application.

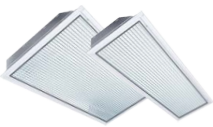

Germicidal Recessed Troffers



Germicidal Door Barrier



Corner Mount Upper Air Germicidal Eradicator



Wall Mount Upper Air Germicidal Eradicators



Germicidal Handheld Wand

RECESSED TROFFER Germ Air Treatment

GRT

120 - 277VAC

MOUNTING

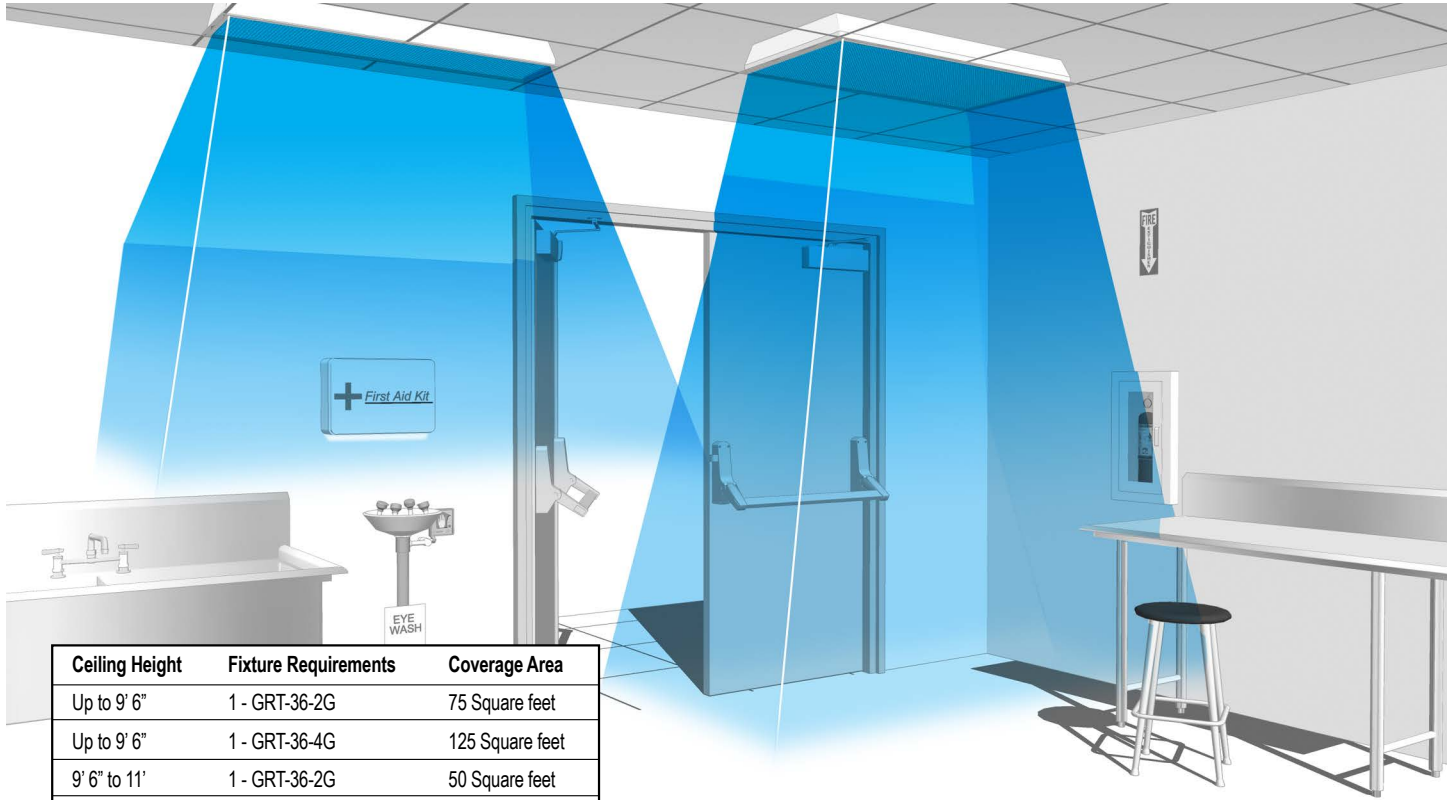

Ceiling Height	Fixture Requirements	Coverage Area
Up to 9' 6"	1 - GRT-36-2G	75 Square feet
Up to 9' 6"	1 - GRT-36-4G	125 Square feet
9' 6" to 11'	1 - GRT-36-2G	50 Square feet
9' 6" to 11'	1 - GRT-36-4G	100 Square feet
11' to 14'	1 - GRT-36-2G	40 Square feet
11' to 14'	1 - GRT-36-4G	70 Square feet

DIMENSIONS

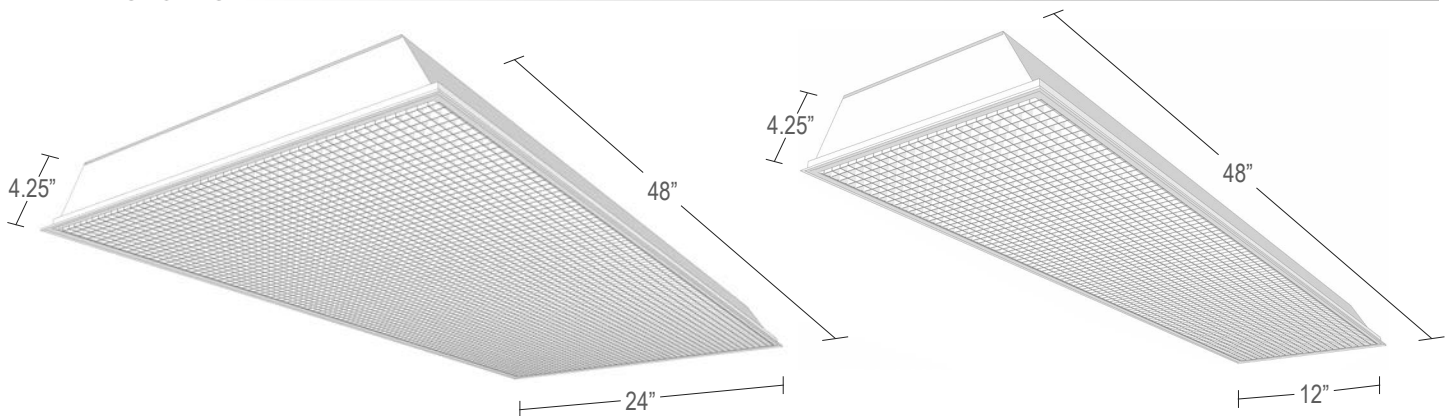

PRODUCT DESIGNATIONS

