

# DOOR BARRIER Germ Air Treatment

## GDB

120 - 277vAC



Each fixture acts as a concentrated curtain of germicidal UV energy increasing personnel safety.

Lighting Solutions For  
**Healthcare • Hospitality**  
**Educational • Institutional**

Cat. #	Type
Notes	

### DESIGNATIONS



### KEY FEATURES AND BENEFITS

- Industry leading US design, manufacturing and distribution.
- Provides up to 300 square feet of air disinfection.
- Improves Indoor Air Quality (IAQ) by cleaning air handling systems.
- Germicidal lamps are 254 nm / 12,000 hour life. (less than 8mg of mercury/lamp)
- Lamps are well shielded for vision safety.
- Reduces the risk of illness associated with air handling systems
- Cleans entry, preventing airborne transmission of bacteria and viruses.
- All components are in one integrated assembly for easy serviceability.
- Produces no ozone or other secondary contaminants

### APPLICATIONS

- Hospitals
  - Clean Rooms
  - Sterile Packaging
  - Bakery
  - Food Processing
  - Pediatric Wards
  - Prisons
  - Laboratories
  - Contagion Wards
  - Bottling Plant
  - Delivery Room
  - Cosmetic Manufacturing
  - Clinics
  - Autopsy Rooms
  - Chemistry Lab
  - Brewery
  - Ampule Filling
- Areas requiring a clean curtain of air treatment for entering occupants.

### SPECIFICATIONS

**Wattage** 39 Watt UVC Lamp  
**Input Voltages** 120-277vAC  
**Body Material** Hospital Grade Powder Coated Stainless Steel

**Direction Handling** Spectrally-polished Reflector and Louvres  
**Transformer** UL listed 420mA Transformer

### PRODUCT ORDERING SELECTION

Above Door Mounted Air Treatment	
<input type="checkbox"/>	GDB-36/T Door Barrier Air Treatment
<input type="checkbox"/>	GML005T Shatterproof Lamp for DB-36-T Fixture

**Germicidal Disinfectant Fixtures for Any Application.**

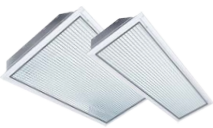

Germicidal Recessed Troffers



Germicidal Door Barrier



Corner Mount Upper Air Germicidal Eradicator



Wall Mount Upper Air Germicidal Eradicators



Germicidal Handheld Wand

# DOOR BARRIER Germ Air Treatment

GDB

120 - 277VAC

## MOUNTING

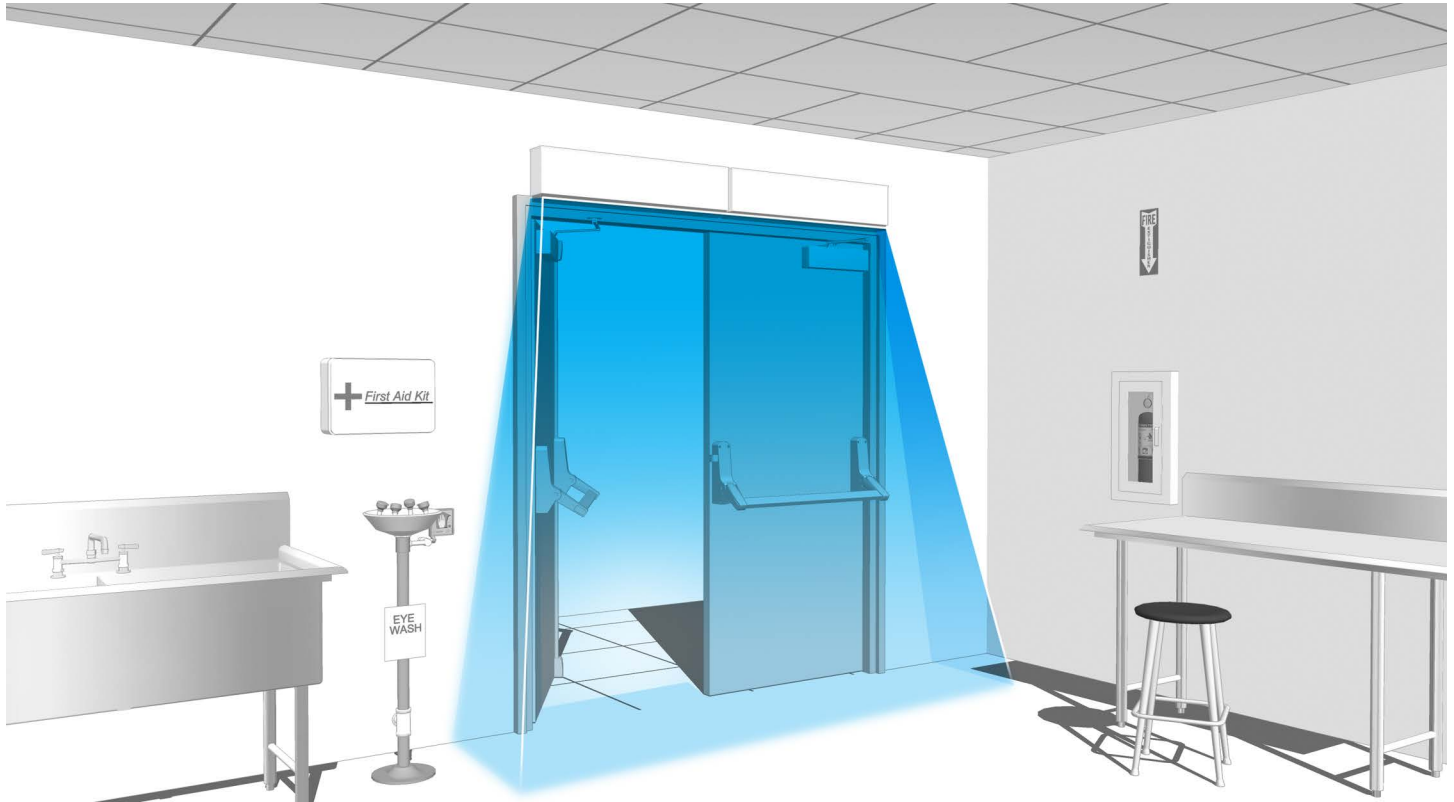

## DIMENSIONS

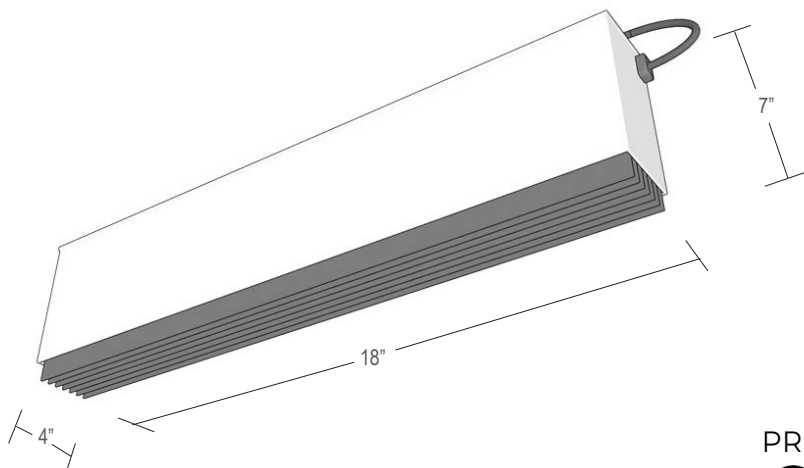

Specifications and data are subject to change without notice.

PRODUCT DESIGNATIONS

