

The D2D DUSK TO DAWN Parking Lot and Utility Light

UQDD

120 - 277vAC



Cat. #	Type
Notes	

DESIGNATIONS



IP66

ANSI/UL 1598, 8750



KEY FEATURES AND BENEFITS

- Energy efficient 42 watt size at 4100 Kelvin.
- Optional slip-fit easy mounting galvanized pipe bracket
- An optical distribution designed to replace HID lighting systems.
- Easily replaces HID from 100w to 175w MH or HPS.
- Sealed LED array compartment.
- Gray Powdercoat Finish over a Chromate Conversion Coating.

APPLICATIONS

Anywhere overhead pole lighting is required, such as retail centers, industrial parks, schools and universities, public transit and airports, office buildings and medical facilities

SPECIFICATIONS

Name	D2D Dusk to Dawn
Category	Parking Lot and Area Lighting
Model	#UQDD
Color	Gray
Housing	Die Cast Gasketed Aluminum Housing with Integral Heat Sinking
Voltage	120-277vAC
Lens	Clear Prismatic Polycarbonate Lens
Beam Angle	Type V Distribution
IP Rating	IP66

Wattage	42w (175w HID Equivalent)
Lumen Output	3,872
Efficacy	96.8 Lumens per Watt
Operating Temperature	-40°C to +50°C
Lifetime	70,000 hr. at L ₇₀
Color Temp	4100 Kelvin
Dimming	1-10Vdc
Warranty	5-Year Limited

42 watts	3,872 Lumens
----------	--------------

PRODUCT ORDERING SELECTION

UQDD	042	41	U			
Series	Type-Watts	Kelvin	Voltage	Colors	Options	Mounting Options
UQDD	<input type="checkbox"/> 042 - 42w	<input type="checkbox"/> 41 - 4100K	<input type="checkbox"/> U - 120-277	<input type="checkbox"/> G - Gray <input type="checkbox"/> RAL - Custom Color	<input type="checkbox"/> SF - Single Fuse <input type="checkbox"/> DF - Double Fuse <input type="checkbox"/> SP - Surge Protection	<input type="checkbox"/> A12 - Mounting Arm <input type="checkbox"/> SCMA13 - 12" Galvanized Mounting Arm with Wall Bracket <input type="checkbox"/> SC25SHB - Cutoff Shield, Black

The D2D DUSK TO DAWN Area Light

UQDD

120 - 277VAC

MOUNTING / ACCESSORIES / PHOTOMETRICS

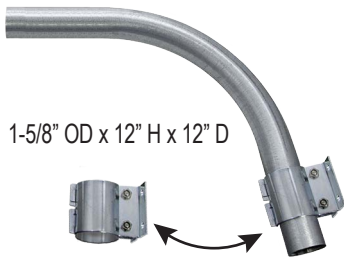

1-5/8" OD x 12" H x 12" D

12" Galvanized Mounting Arm
with Wall Bracket
SCMA13



Black UV Resistant Molded
Polycarbonate Cutoff Shield
SC255HB

Type V
Photometric
Distribution

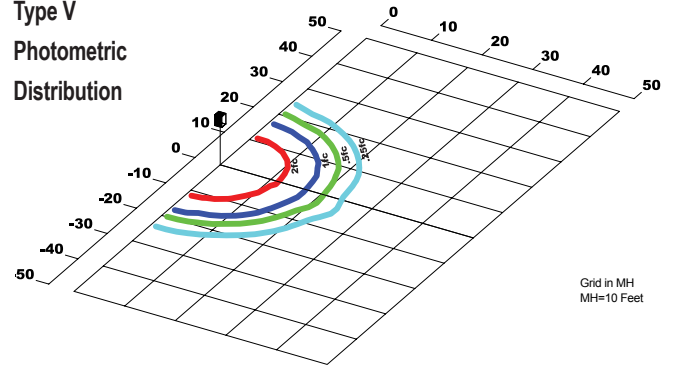

EFFECTIVE PROJECTED AREA (EPA) - Utilizing 12" Mounting Arm

CONFIGURATION
One Fixture
EPA - 0.40
WEIGHT - 8 lbs.



CONFIGURATION
Two Fixtures @ 180°
EPA - 0.80
WEIGHT - 16 lbs.



CONFIGURATION
Two Fixtures @ 90°
EPA - 0.55
WEIGHT - 16 lbs.

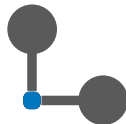

CONFIGURATION
Three Fixtures @ 90°
EPA - 0.88
WEIGHT - 24 lbs.

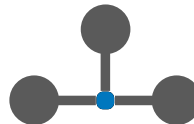

CONFIGURATION
Three Fixtures @ 120°
EPA - 0.80
WEIGHT - 24 lbs.

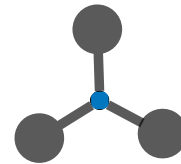

CONFIGURATION
Four Fixtures @ 90°
EPA - 0.88
WEIGHT - 32 lbs.

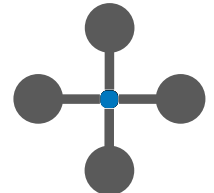

[CLICK HERE](#)
To Access POLES

DIMENSIONS

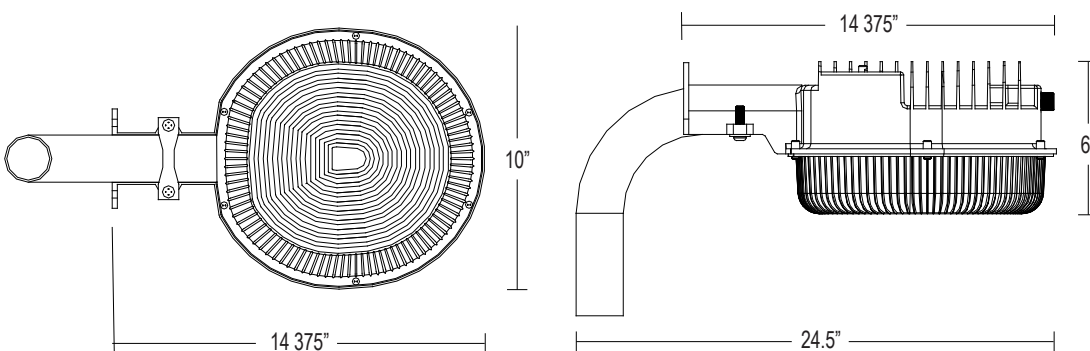

WEIGHT RANGE
8 lbs.

PRODUCT DESIGNATIONS

